

Chapter - 14

Semiconductor And Electronic Devices

* Classification of Metals, Conductors And Semi-Conductors on the basis of conductivity.

On the basis of the relative values of electrical Conductivity (σ) or int resistivity ($\rho = \frac{1}{\sigma}$), the solids are broadly classified as.

i) Metals \rightarrow They possess very low resistivity (or high conductivity)

$$\rho \sim 10^{-2} \text{ to } 10^{-8} \Omega \text{ m,}$$
$$\sigma \sim 10^2 \text{ - } 10^8 \text{ S m}^{-1}$$

ii) Semiconductors \rightarrow They have resistivity or conductivity intermediate to metals & insulators.

$$\rho \sim 10^{-5} \text{ - } 10^6 \Omega \text{ m}$$
$$\sigma \sim 10^{+5} \text{ - } 10^6 \text{ S m}^{-1}$$

iii) Insulators \rightarrow They have resistivity (or low conductivity)

$$\rho \sim 10^{11} \text{ - } 10^{19} \Omega \text{ m,}$$
$$\sigma \sim 10^{-11} \text{ - } 10^{-19} \text{ S m}^{-1}$$

★ The values of f and σ given above are indicative of magnitude & could well go outside the range as well.

Types of Semiconductors

(i) Element Semiconductor → These semiconductors are available in natural form.

e.g → Silicon and Germanium.

(ii) Compound Semiconductor → These semiconductors are made by compounding the metal. e.g.

(a) Inorganic Semiconductors are → CdS, GaAs, CdSe, InP, etc.

(b) Organic Semiconductors are → anthracene, doped, Phthalocyanines etc.

(c) Organic Polymer semiconductors are → Polypyrrole, Polyaniline, Polythiophene etc.

ENERGY BANDS IN SOLIDS

(conductor, Insulator, & Semiconductor)

Energy Band

In a crystal due to interatomic interaction, valence electrons of one atom are shared by more than one atom in the crystal. Now splitting of energy level takes place. The collection of these closely spaced energy levels are called an energy band.

★ According to Bohr's atomic model and concept of electronic configuration in an isolated atom, the electrons have to contain definite discrete amounts of energy corresponding to different shells & subshells.

These bands are formed due to the continuous energy variation in different energy levels.

Valence Band

Valence band contains valence electrons. The valence band can be completely filled with electrons or sometimes partially filled with electrons but it is never empty. As there are valence electrons they are not affected by the electric field.

Conduction Band

Conduction band contains free electrons it can be empty or partially filled with electrons as these are free electrons they conduct electricity through the material.

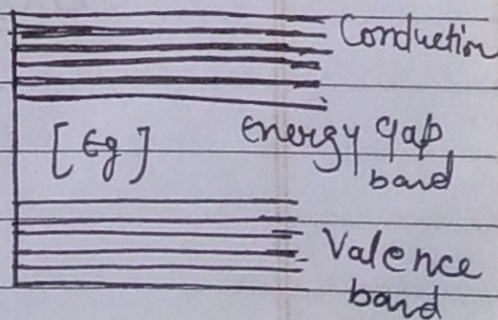

Forbidden band or Energy Gap [E_g]

The forbidden band is completely empty as there are no electron in it to move an electron from valence band to the conduction band an energy equal to the energy gap is required.

$$[E_g = h\nu = hc/\lambda]$$

where, $h =$ Planck's constant.

$c =$ velocity of light

Fermi Energy

It is difficult maximum possible energy possessed by free electrons of a material at absolute zero temperature. (i.e 0K)

★ The value of Fermi energy is different for different materials.

Difference b/w Conductor, Insulator
& Semiconductor on the
basis of Energy bands

Conductor (Metal)

In Conductor, either there is no energy gap between the conduction band which is partially filled with electrons & valence band or the conduction band and valence band overlap each other.

Thus, many electrons from below the fermi level can shift to higher energy levels above the fermi level in the conduction band & behave as free electrons by acquiring a little more energy from any other sources.

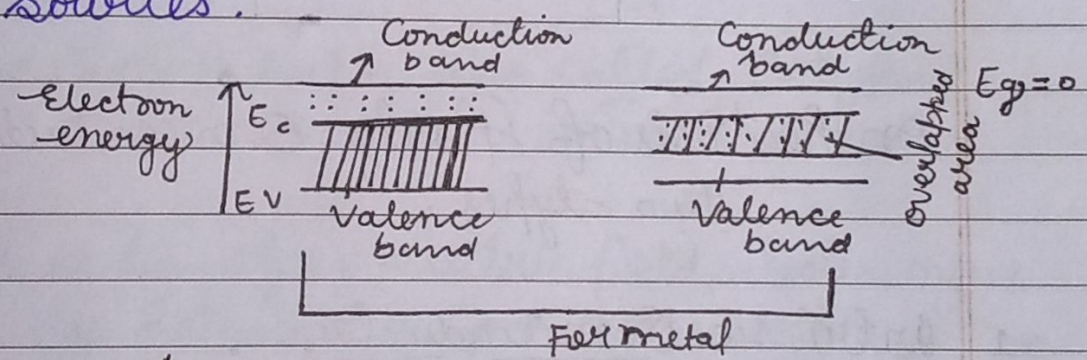

Insulator

In insulator, the valence band is completely filled, the conduction band is completely empty. In this, energy gap is quite large & even energy from any other source cannot help electrons to overcome it.

Thus, electrons are bound to valence band and are not free to move. Hence, electric conduction is not possible in this type of material.

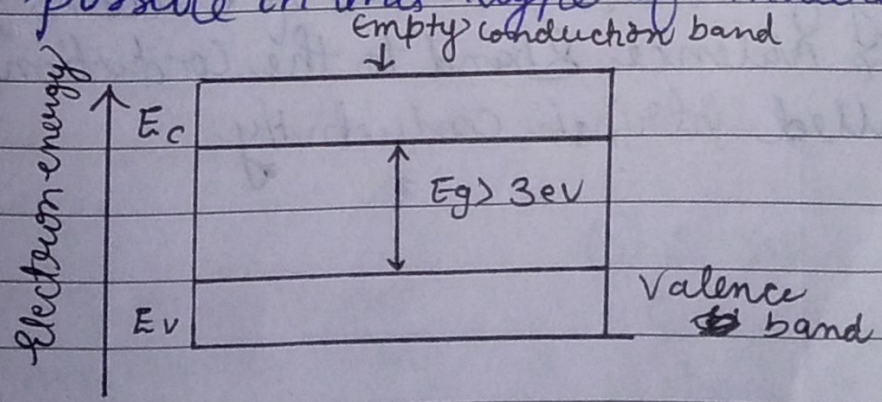

Semiconductor

In semiconductor, the valence band is totally filled and the conduction band is empty but the energy gap between conduction band and valence band, unlike insulators is very small.

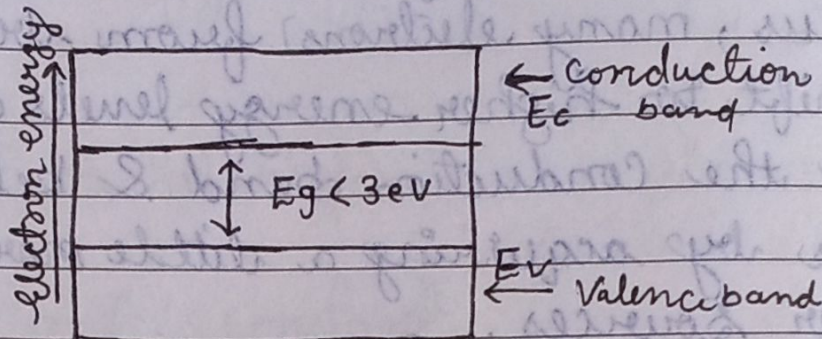

On the basis of Purity, Semiconductors are of two types.

1 Intrinsic Semiconductor

- A pure semiconductor which is free of any impurity is called intrinsic semiconductor.
- Without any significant presence of dopant species.
- The electrical conductivity of a pure semiconductor is totally governed by the no. of electrons excited from the valence band to the conduction band & is called intrinsic conductivity.

- In intrinsic semiconductor at room temperature, Fermi level is about half way in the energy gap.

- The No. of free electrons & holes are exactly equal in an intrinsic Semiconductor

$$n_e = n_h = n_i$$

Where, n_e & n_h are number densities of electrons & holes respectively & n_i is called intrinsic carrier concentration

- An intrinsic semiconductor also called i-type Semiconductor

Under the action of an electric field, holes move towards $-ve$ potential giving hole current I_h . The total current I is the sum of the electron current I_e & the hole current I_h i.e.

$$[I = I_e + I_h]$$

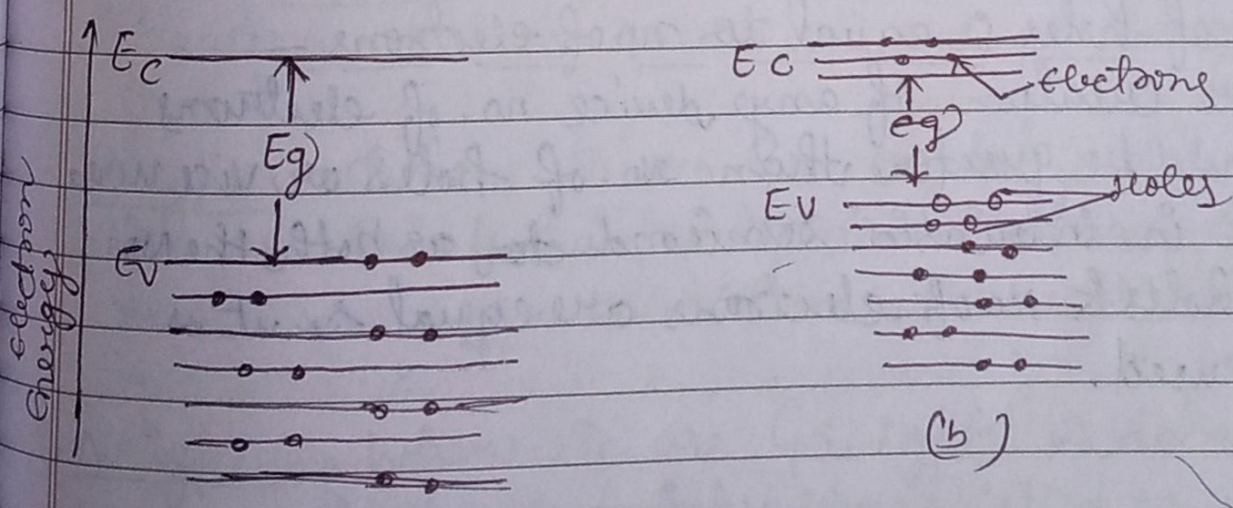

(a)

(b)

(a) $T = 0K$ (semiconductor behave like insulator)

(b) is representing thermally generated electron-hole pairs at $T > 0K$

Drawbacks for i Semiconductor

- i Current is controlled by temperature - In intrinsic semiconductor, when electrons get thermal energy, electrons move from ~~valance~~ valance band to conduction band more will the thermal energy, more more will be the no. of electrons in conduction band & more will be the current hence current is controlled by temperature not by us.
- ii Current is very small - Intrinsic semiconductor can conduct only a small amount of current at ~~room~~ normal temp. to increase the current the semiconductor should be constantly heated which is not suitable hence for devices that requires large amount of current, semiconductor can not be used.
- iii No of holes is equal to no of electrons - For creation of any device no. of electrons should be greater than no. of holes or vice versa. But in intrinsic semiconductor, as both the no of holes & no of electrons are equal so it is not used.

Date: _____ Page: _____

Extrinsic Semiconductor

The conductivity of intrinsic semiconductors is very low at room temperature. But it can be increased, if some pentavalent or trivalent impurity is mixed with it.

* Doping

Doping is a mixing semiconductor with a CHOICE in a MEASURED quantity, in other words the process of adding impurity to pure semiconductor is called doping.

The product formed after doping is called doped semiconductor or Extrinsic Semiconductor. Doping is represented in parts per million (PPM) i.e. if we use 3ppm in doping of Si with Al this means 3 atom of aluminium are added in one million atom of Si. Doping is done using neighbouring element only to show that it does not affect the crystal structure of semiconductor.

Doping can be classified in 2 types

① P-type → when Si or Ge crystal is doped with trivalent impurity is called as p-type doping, e.g. Aluminium, Boron & Indium

② N-type → when Si or Ge crystal is doped with pentavalent impurity is called as n-type doping, e.g. Phosphorus, Sb, P etc.

Majority charge carrier - electron
Minority " " - holes

electron donor

★ n-type Extrinsic Semiconductor
When Si or Ge crystal is doped with Pentavalent impurity we get n-type Semiconductor.

e.g of Pentavalent atom \rightarrow P, As, Sb

Pentavalent atom has 5 electron in its Valance shell. fig shows the structure of n-type semiconductor. Every pentavalent dopant atom finds 4 Si neighbouring Si atom it shares 4 valence electrons with Si atom its form octate & Si atom become stable since valance orbit can hold maximum 8 electron the one extra electron of dopant atom is not the part of covalent bonding and hence it becomes free electrons.

The free e^- of phosphorus atom has energy 0.01 eV less than the conduction band energy of Si at room temperature these free electrons moves to the conduction band & are available for conduction of electricity.

Due to these extra free electrons in the crystal structure the no. of electrons becomes greater than the no of holes in the crystal.

NOTE

No. of holes will decrease but will never become 0, there would be a small no. of holes present in the crystal.

Total No. of Charge Carriers

$$[n_e \times n_h = n_i^2]$$

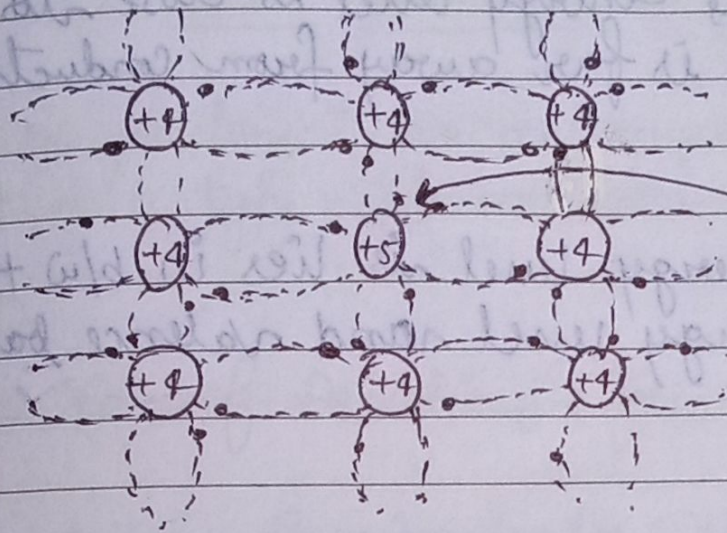

e^- unbonded free electron donated by pentavalent (+5 valency) atom

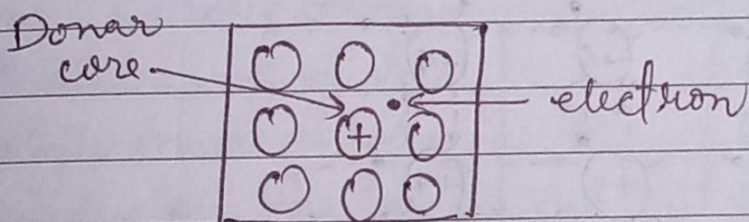

Fig - Pentavalent donor atom (As, Sb, P etc) doped for tetravalent Si or Ge giving n-type Semiconductor

★ p-type Extrinsic Semiconductor

- Obtained by doping the Si or Ge with trivalent impurity atoms i.e. those atoms which have three valence electrons in their valence shell.

- The impurity atoms added, create vacancies of electrons (i.e. holes) in the structure & are called acceptors. The holes are majority carriers & electrons are minority carriers.

- The holes density (n_h) is much greater than the electron density (n_e) i.e. $n_h \gg n_e$

- The acceptor energy level is close to valence band is far away from conduction band.

- The fermi energy level lies in b/w the acceptor energy level and valence band.

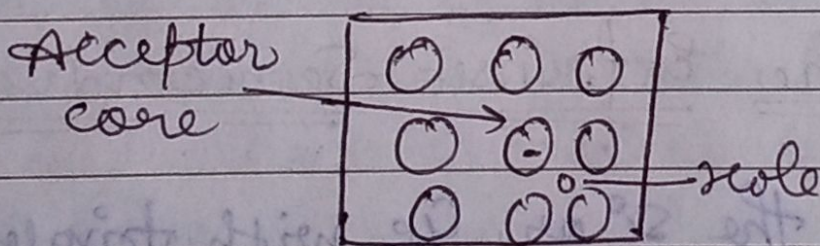
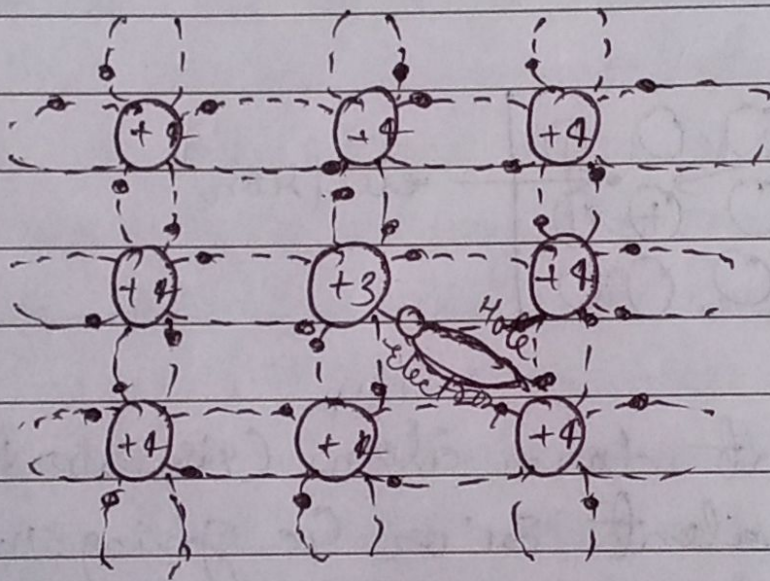

Fig - Trivalent acceptor atom [In, Al, B etc] doped in tetravalent Si or Ge lattice giving p-type Semiconductor.

P-N Junction (Diode)

A p-n junction is an arrangement made by a close contact of n-type Semiconductor & p-type Semiconductor.

* Formation of Depletion Region in P-N Junction

In a n-type Semiconductor, the concentration of electrons is more than concentration of holes. Similarly, in a p-type Semiconductor, the conc.

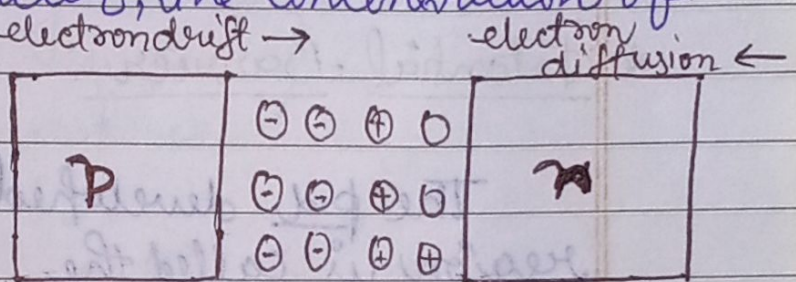

of holes is more than that of conc. of e^- .

During formation of p-n junction & due to the concentration gradient across p & n-sides, holes diffuse from p-side to n-side ($p \rightarrow n$) & electrons diffuse from n-side to p-side ($n \rightarrow p$).
 Fig. P-N Junction formation process

The diffuse e^- s comes into contact with holes on the p-side & are eliminated by recombination. Same happens for the diffused holes on the n-side.

Thus near the junction, the charge is built on n-side & -ve charge on p-side. This setup $\phi.d$ across the junction & an internal electric field E_i directed from n-side to p-side. The Equilibrium is established when the field E_i becomes strong enough to stop further diffusion of the majority charge carriers.

★ Depletion region / layer :-

The region on either side of the junction which becomes depleted (free) from the mobile charge carriers is called depletion region or layer.

- The width of depletion region is of the order of 10^{-6} m.

★ Potential Barrier :

The p.d. developed across the depletion region is called the potential barrier.

- Potential barrier depends on dopant concentration in the semiconductor & temp. of the junction.

Biasing of PN Junction

Biasing is the process of applying p.d. to the semiconductor. Biasing is achieved by applying Emf across the PN Junction diode.

Biasing can be of 2 types

- i) Forward Biasing
- ii) Reverse Biasing

i) Forward Biasing

A p-n junction diode is said to be forward bias when the +ve terminal of the battery is connected to p-type & -ve terminal to n-type Semiconductor.

- Width of depletion layer decreases.

- p-n junction offers very low resistance.

- An ideal diode have zero resistance

$$[V = V_{induced} + V_{applied}]$$

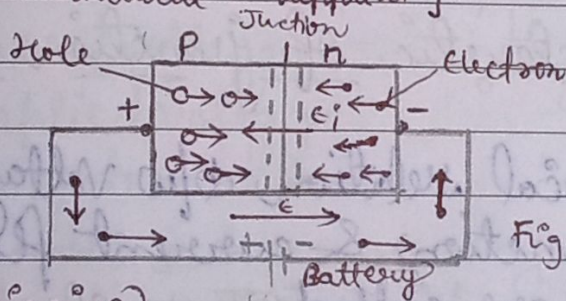

Fig. Forward biasing of Junction diode.

ii) Reverse Biasing

A p-n junction is said to be reverse biased when the +ve terminal of battery connected to n-type & -ve terminal to p-type Semiconductor.

- Width of depletion layer increases.

- p-n junction offers very high resistance.

- An ideal diode have infinite resistance.

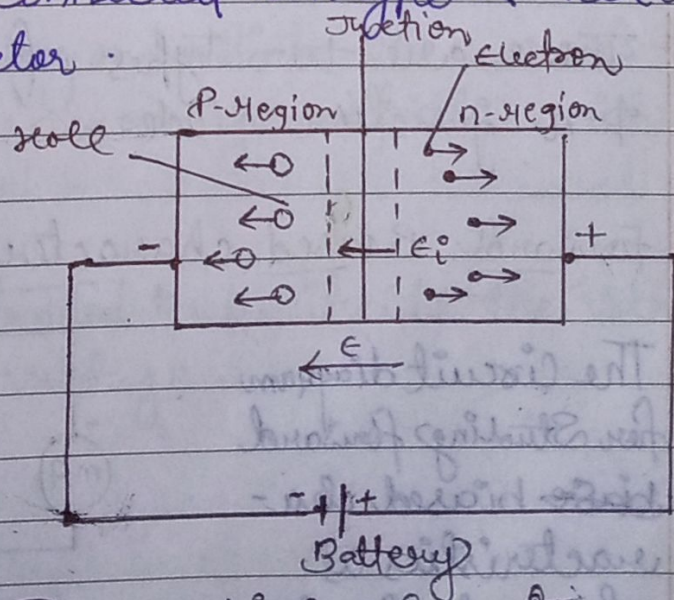
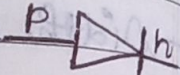

Fig. Reverse biasing of junction diode.

P-n junction Diode

A Semiconductor diode is basically a p-n junction with metallic contacts provided at the ends for the application of an external voltage.

- A p-n junction diode is represented as 

- The direction of arrow indicates the Conventional direction of current (when the diode is under forward bias)

* I-V Characteristic of junction diode

The Graphical relation b/w voltage applied across p-n junction & current flowing through the junction are called I-V characteristic of p-n junction diode.

There are two types of characteristics of a p-n junction diode.

i) Forward Biased characteristic:-

The circuit diagram for studying forward biased characteristics is shown in the figure.

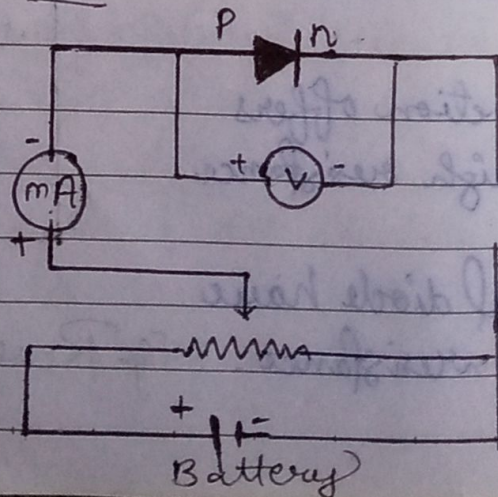

starting from a low value, forward bias voltage is increased step by step. (measured by voltmeter) and forward current is noted (by ammeter) & a graph is plotted b/w Voltage & current.

The curve so obtained is the forward characteristic of the diode.

At the start when applied voltage is low, the current through the diode is almost zero. It is because of the potential barrier which opposes the applied voltage.

Till the applied voltage exceeds the potential barrier,

the current increases very slowly with increase in applied voltage (OA). With further increase in applied voltage, the current increases rapidly (AB), in this situation, the diode behaves like a conductor.

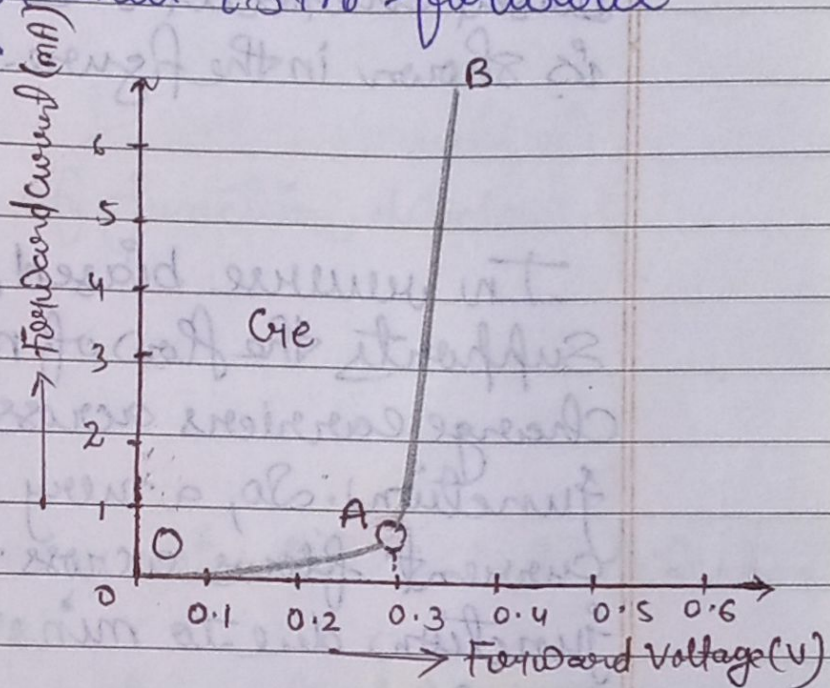

→ The forward voltage beyond which the current through the junction starts increasing rapidly with voltage is called knee voltage.

→ If the line AB is extended back, it cuts the voltage axis at potential barrier voltage.

ii) Reverse Biased Characteristic

The circuit diagram for studying reverse biased characteristics is shown in the figure.

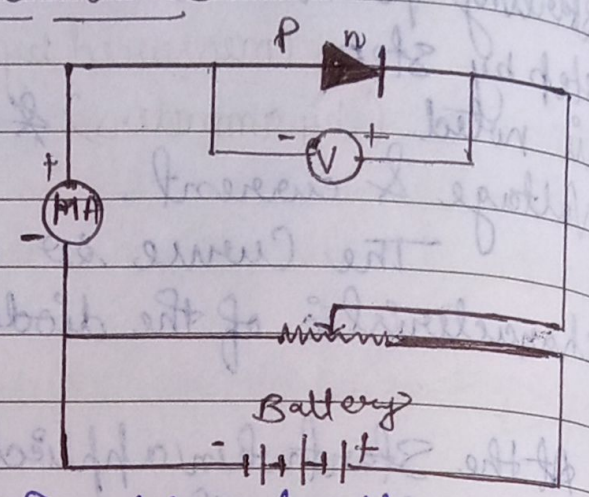

In reverse biased, the applied voltage supports the flow of minority charge carriers across the junction. So, a very small current flows across the junction due to minority charge carriers.

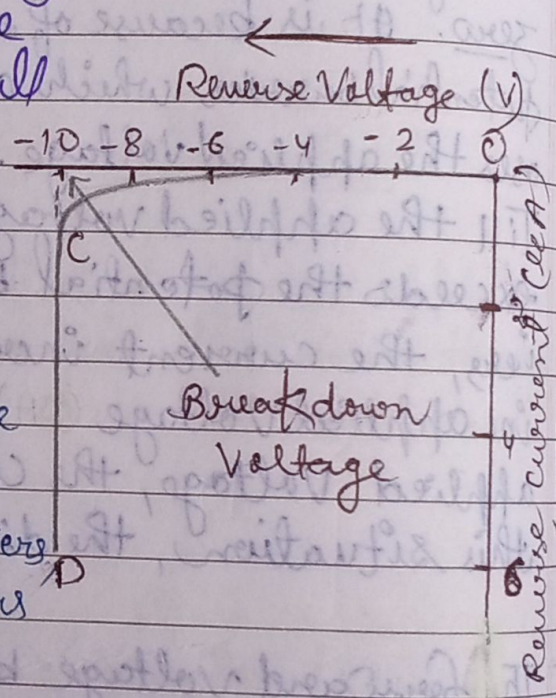

Motion of minority charge carriers is also supported by internal potential barriers. So all the minority carriers cross over the junction.

Therefore, the small reverse current remains almost constant over a sufficient long range of reverse bias increasing very little with increasing voltage (OC).

→ This reverse current is voltage independent upto certain voltage into known as breakdown voltage & this voltage independent current is

called reverse saturation current.

→ The DC resistance of junction Diode,

$$r_{DC} = \frac{V}{I}$$

→ The dynamic resistance of junction diode.

$$r_{AC} = \frac{\Delta V}{\Delta I}$$

→ Use of P-n Junction characteristics in Rectification.

From forward & reverse characteristic, it is clear that current flow through the junction diode only in forward bias not in reverse bias i.e., current flows only in one direction.

★ P-N Junction Diode As a Rectifier

The process of converting alternating voltage/current into direct voltage/current is called rectification.

→ Diode is used as a rectifier for converting alternating current/voltage into direct current/voltage.

→ There are two ways of using a diode as a rectifier i.e. Half wave Rectifier & Full wave Rectifier.

* a) p-n Junction Diode as a Half-Wave Rectifier

- Principle - Its working based on the principle that junction diode offer very low resistance in forward bias & very high resistance in reverse bias.

Circuit diagram of p-n junction diode as half-wave rectifier is shown below.

AC voltage to be rectified is connected to the primary coil of a Step-down transformer.

Secondary coil is connected to the diode through resistors R_1 , across which output is obtained.

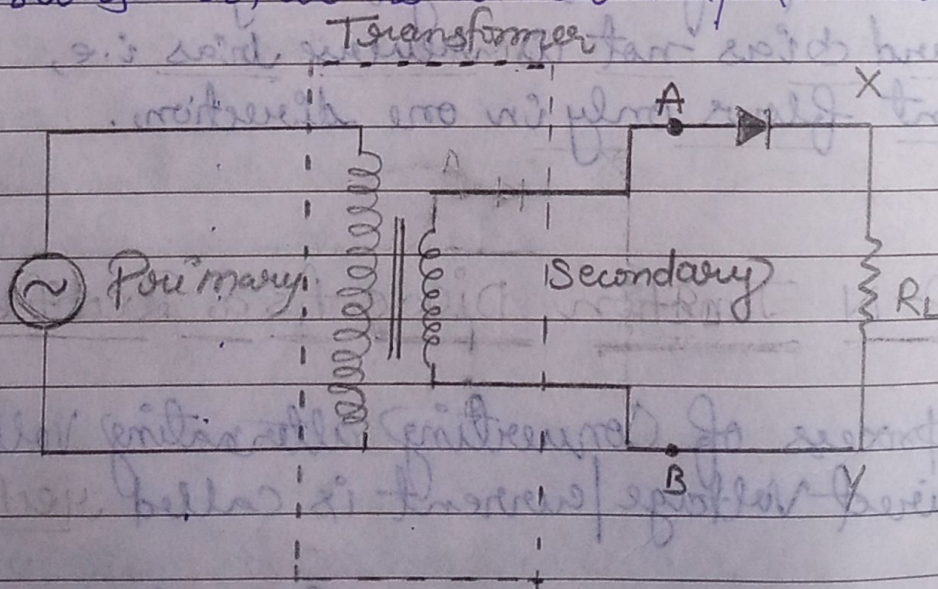

Working

During the half cycle of the input AC, the p-n junction is forward biased. Thus the resistance in p-n junction becomes low & current flows, hence we get output in the load.

During the half cycle of the input AC, the p-n junction is reverse biased. Thus the resistance of p-n junction is high & current does not flow. Hence no output in load.

So, for complete cycle of AC, current flows through the load resistance in the same direction.

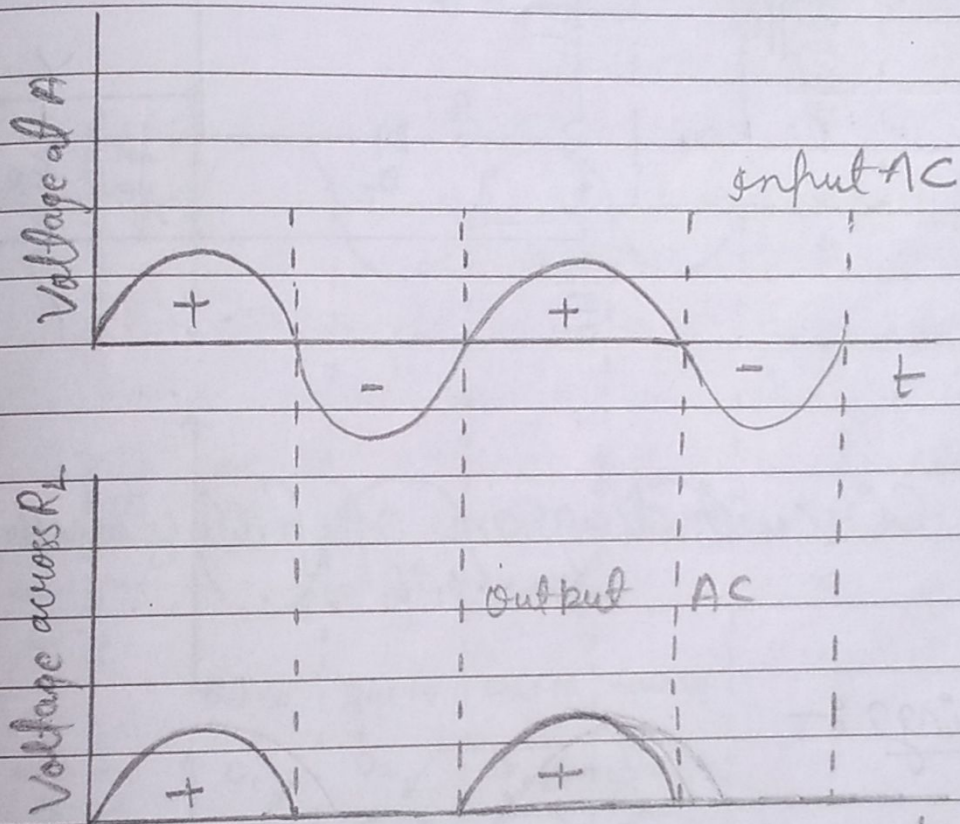

Fig - Input & output waveforms

b) p-n Junction Diode as a Full-wave Rectifier.

- Principle - Its working based on the principle that junction diode offers very low resistance in forward bias & very high resistance in reverse bias.

Current diagram of full-wave rectifier is shown below. For all full wave rectification we have to use two

p-n junction diodes D_1 & D_2

centre tap
transformer

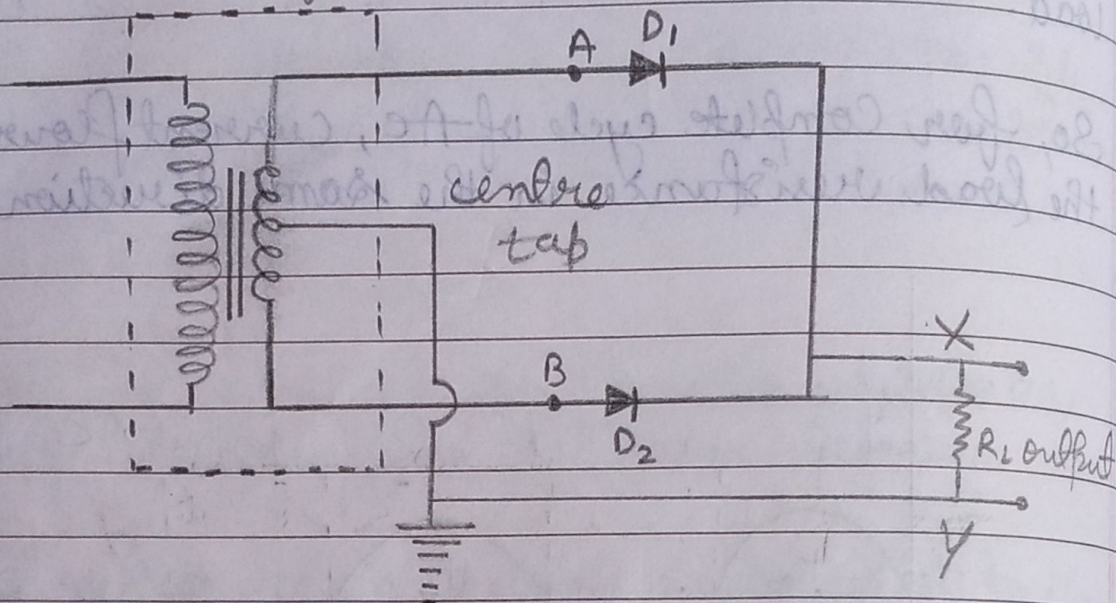

Circuit diagram of full wave
rectifier.

Working :-

During the +ve half cycle of the input A.C, the junction diode D_1 is forward biased, & the p-n junction diode D_2 is reverse biased. The forward current flows on account of majority carriers of junction diode D_1 in the dirⁿ shown.

During the -ve half cycle of the input A.C, the junction diode D_1 is reverse biased & the junction diode D_2 is forward biased. The

forward current flows on current of majority carriers of junction Diode D_2 .

we observe that during both the halves, current through R flows in the same direction.

The input & output waveforms have been given below

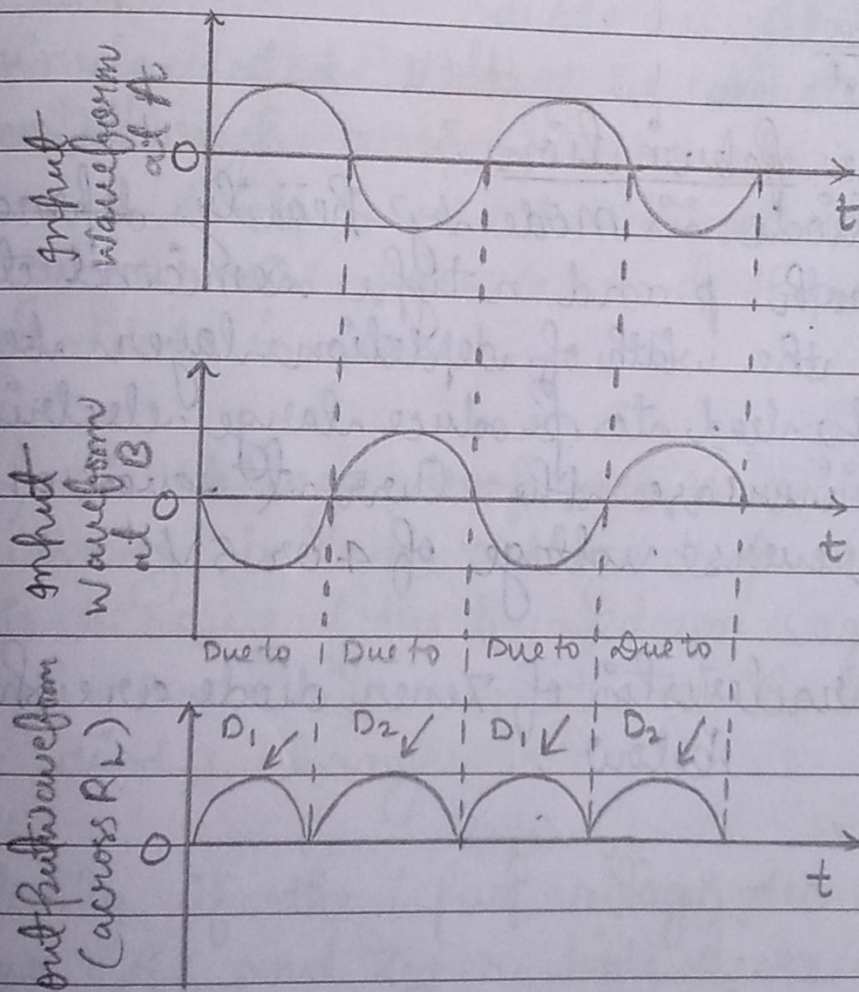
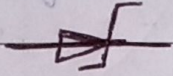

Fig - Input & output waveforms

Zener Diode

Zener diode is a reverse biased heavily doped p-n junction diode.

It is operated in reverse breakdown region.

Its symbol is 

Zener diode fabrication.

Zener diode is made by heavily depending doping of both p and n type semiconductors & hence, the width of depletion layer becomes thin which lead to produce large electric field to increase the current even on applying reverse voltage of 4 or 5V.

V-I characteristic of Zener diode are shown below.

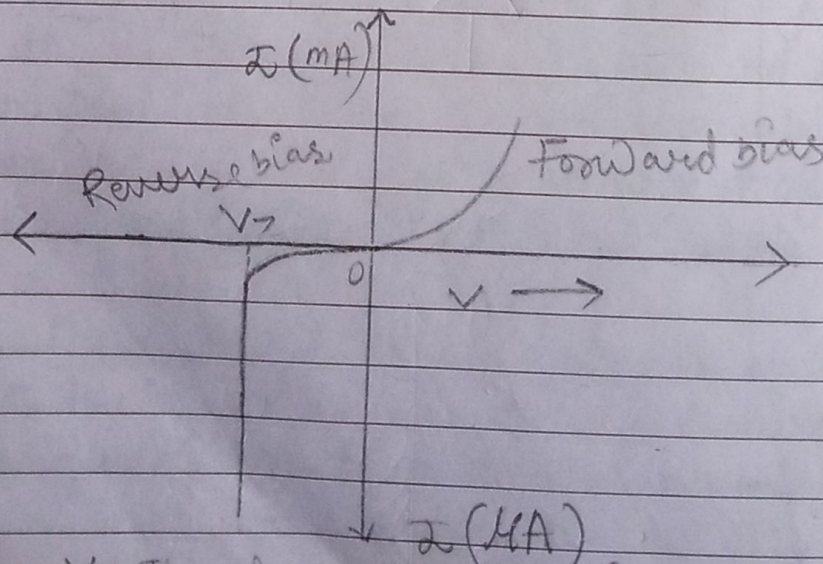

Fig- V-I characteristic of a Zener diode

Date: _____ Page: _____
* Zener Diode as a Voltage Regulator:

Voltage regulator converts an unregulated DC output of rectifier into a constant regulated DC voltage, using Zener diode.

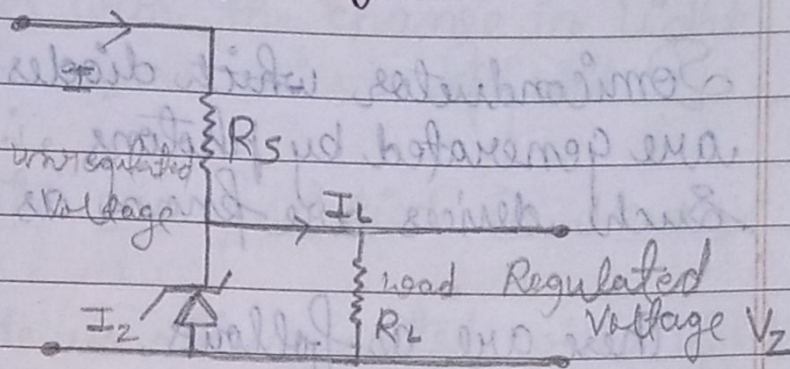

Fig - Circuit diagram of Zener diode as voltage regulator.

The unregulated voltage is connected to the Zener diode through a series resistance R_s such that the Zener diode is reverse biased. If the input voltage increases, then current through R_s and Zener diode increases.

Thus, the voltage drop across R_s increases without any change in the voltage drop across Zener diode. This is because of the breakdown region, Zener voltage remain constant even though the current through Zener diode changes.

Similarly, if the input voltage decreases, the current through R_s and Zener diode decreases. The voltage drop across R_s decreases without any change in the voltage across the Zener diode.

Now, any change in input voltage results the change in voltage drop across R_s without any change in voltage across the Zener diode. Thus, Zener diode acts as a voltage regulator.

Optoelectronic Devices

Semiconductor which diodes in which carriers are generated by photons, i.e. photo-excitation. Such devices are known as optoelectronic devices.

These are as follows.

1) Photodiode

Photodiode is an optoelectronic device in which current carriers are generated by photons through photo excitation, i.e. photoconduction by light.

→ A photodiode is a special type of junction diode used for detecting optical signals.

→ It is a reverse biased p-n junction made from a photosensitive material.

→ Its symbol is

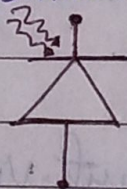

→ Its V-I characteristics of photodiode are shown below.

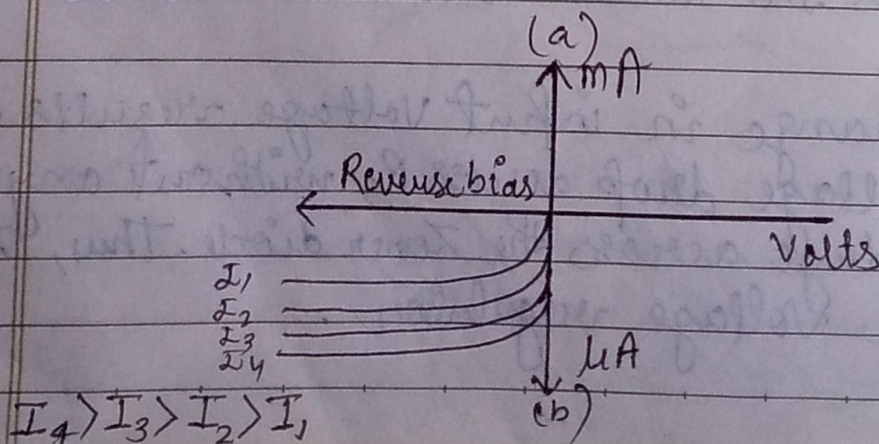

we observe from the figure that current in photodiode changes with the change in light intensity (I) when reverse bias is applied.

* Reason to operate the photodiode in reverse bias:

When photodiode is illuminated with light due to breaking of covalent bonds, equal number of additional electrons and holes comes into existence whereas fractional change in minority charge carrier is much higher than fractional change in majority charge carrier. Since, the fractional change of minority carrier current is measurable significantly in reverse bias than that of forward bias, therefore, photodiode are connected in reverse bias.

* Photodiodes are used for following purposes:

- i) In photodetection for optical signals.
- ii) In demodulation for optical signals.
- iii) In switching the light on & off.
- iv) In optical communication equipments.
- v) In logic circuit that require, stability & high speed.
- vi) In reading of computers, punched cards & tapes etc.

2) Light Emitting Diode (LED)

It is a heavily doped p-n junction diode which converts electrical energy into light energy.

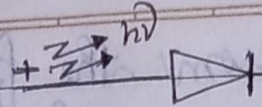
Its symbol is 

V-I characteristics of LED are shown below.

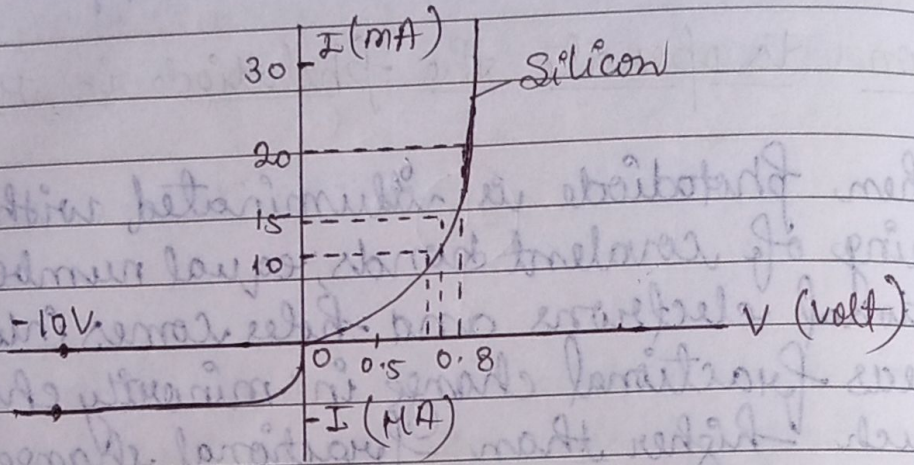

Working of LED

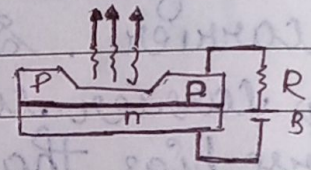

LED forward biased p-n junction which converts electrical energy into optical energy of infrared and visible light region.

Being in forward bias, thin depletion layer and low potential barrier facilitate diffusion of electron and hole through the junction when high energy electron of conduction band combines with the low energy holes in valence band, then energy is released in the form of photon, may be seen in the form of light.

→ The colour of light emitted depends upon the type of material used in making the semiconductor diodes as given below :

- Gallium-arsenide (GaAs) — infrared radiation
- Gallium-phosphide (GaP) red or green light.
- Gallium-arsenide-phosphide (GaAsP) red or yellow light.

→ LEDs emit no light when reversed-biased

→ Semiconductors with appropriate band gap (E_g) close to 1.5 eV are preferred to make LED size. GaAs, CdTe etc.

* The other reasons to select these materials are high optical absorption, availability of raw material & low cost.

* uses of LEDs

- i) In Burglar-alarm systems
- ii) In Calculators and digital watches.
- iii) In the field of optical communication
- iv) In Computers.
- v) In picture phones and video-displays.
- vi) In traffic light.
- vii) In remote control.

* Advantages of LED's over incandescent lamp

- a) Fast action and no warm up time required.
- b) It is nearly monochromatic
- c) low operational voltage and less power consumed.
- d) Fast ON-OFF switching capability.
- e) LED is cheap & easy to handle.

3) Solar cell:

Solar cell is a p-n junction diode which converts solar energy into electrical energy.

- Its symbol is

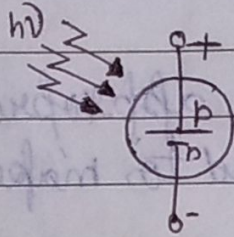

- V-I characteristics of solar cell are shown below.

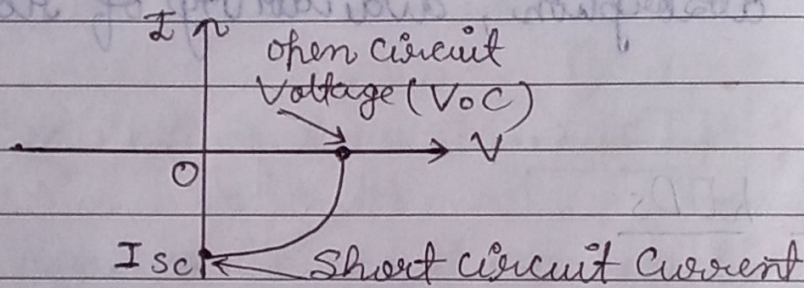

→ The materials used for solar cell are Si and GaAs.

* Uses!

- i) Solar cells are used to power traffic signs.
- ii) Solar cells are used in remote radiotelephones.
- iii) They are used for generating electrical energy in cooking food & pumping water.
- iv) Solar cells are used in calculators, wrist watches & light meters (in photography).
- v) Solar cells are used for charging storage batteries in day time, which can supply the power during night time.

Junction Transistor

A junction transistor is a three-terminal semiconductor device consisting of two p-n junctions formed by placing a thin layer of doped semiconductor (p-type and n-type) b/w two thick similar layers of opposite type.

→ There are two types of transistor:

i) n-p-n transistor → Here, two segments of n-type semiconductor (emitter and collector) are separated by a segment of p-type semiconductor (base).

ii) p-n-p transistor → Here, two segments of p-type (emitter and collector) are separated by a segment of n-type semiconductor (base).

→ Three layers of a transistor is given below -

• Emitter (E) :- It is the left-hand side thick layer of the transistor which is heavily doped.

• Base (B) :- It is a central thin layer of transistor which is lightly doped.

• Collector (C) :- It is the right-hand side thick layer of the transistor is moderately doped.

Emitter	Base	Collector
---------	------	-----------

* Transistors Schematic representation:

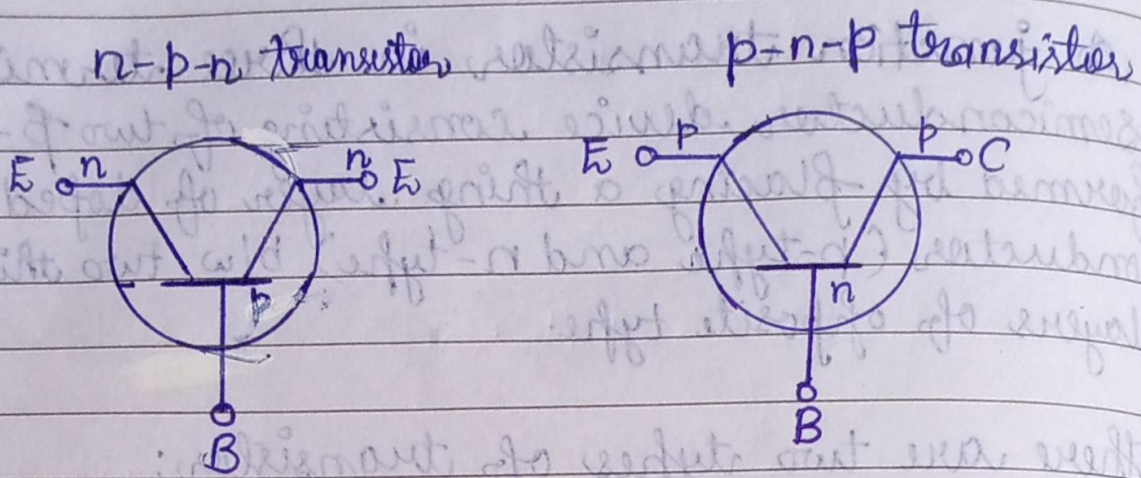

Transistor Biasing

The connection b/w emitter and base should be in forward bias. Transistor consist of 3 terminal out of which any one terminal can be used as common terminal for two distinct circuit the connection b/w the base & collector should be in reverse bias.

* Transistor Configuration:-

- i) Common Base (CB) mode
- ii) Common Emitter (CE) mode
- iii) Common Collector (CC) mode

Characteristics of a Transistor

The graphical representation of the variations among the various current & voltage variables of a transistor are called transistor characteristics.

Transistor Action on working of Transistor.

i) p-n-p Transistor

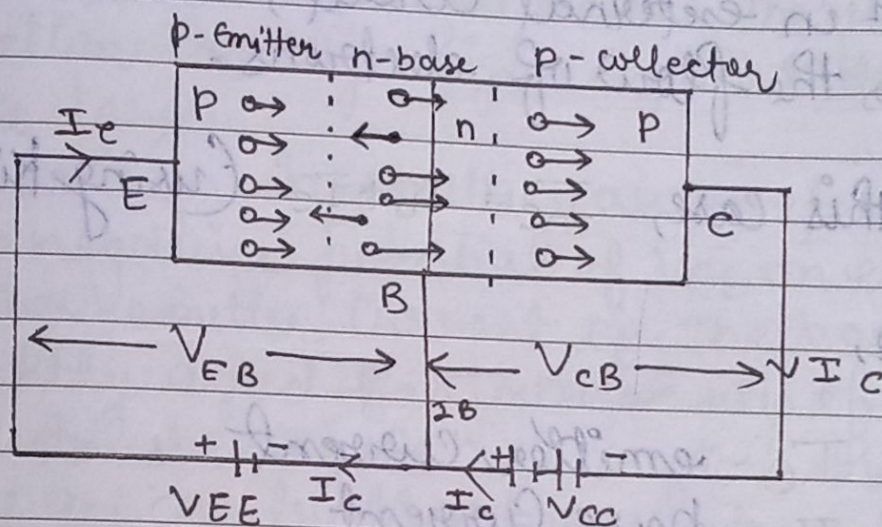

From given figure, we can see that the emitter-base junction is forward biased, Collector-base junction is reverse biased.

The resistance of emitter-base junction is very low. So, the voltage of V_{EE} (V_{EB}) is quite small (i.e., 5V). The resistance of collector-base junction is very high. So, the voltage of V_{CC} (V_{CB}) is quite large (i.e., 45V).

Heavily doped emitter is subjected to electric field by emitter-base battery and consequently, holes get drifted towards collector through thin and lightly doped base region. Nearly 5% hole, which drifted from emitter, combined with electron in base region and remaining nearly 95% hole reaches to collector under the influence of V_{CB} .

The current in p-n-p transistor is carried by holes and at the same time their concentration is maintained.

But in external circuit, the current is due to the flow of electrons.

In this case, $I_e = I_b + I_c$ (using Kirchhoff's law)

Where,

I_e = emitter current

I_b = base current

I_c = collector current

→ In the base I_e & I_c flow in opposite dir.

ii) n-p-n Transistor

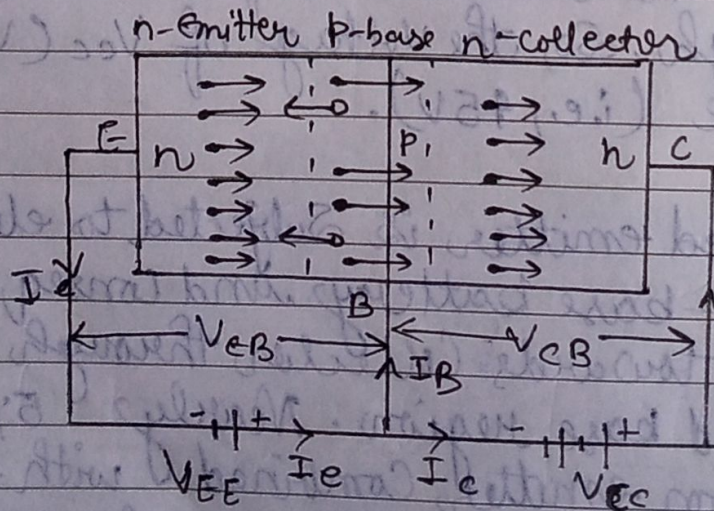

In this transistor, the emitter-base junction is forward biased and its resistance is very low. So, the voltage of V_{EB} is quite small. The collector-base junction is reverse biased. The resistance of this junction is very high. So, the voltage of V_{CB} is quite large.

The electrons in emitter are repelled towards base by negative potential of V_{EB} on emitter, resulting emitter current I_E . The base being thin and lightly doped has low density of holes, thus when electrons enter the base region, then only a few holes get neutralised by electron-hole combination, resulting in base current (I_B).

The remaining electrons pass over to the collector, due to high positive potential of collector, resulting in collector current (I_C).

In n-p-n transistor, the current is carried inside as well as in external circuit by electrons. Thus, in this case also,

$$I_E = I_B + I_C \quad [\text{Kirchhoff's first law}]$$

In the base, I_E & I_C flow in opposite dirⁿ.

* Transistor Configuration:

- i) Common Base (CB) mode
- ii) Common Emitter (CE) mode
- iii) Common Collector (CC) mode

* Characteristics of a Transistor

The Graphical representation of the various current and voltage variables of a transistor are called transistor characteristics.

* Common Base Transistor Characteristics:

Here emitter base circuit is forward biased with battery V_{EB} and collector-base circuit is reverse biased with battery V_{CC} .

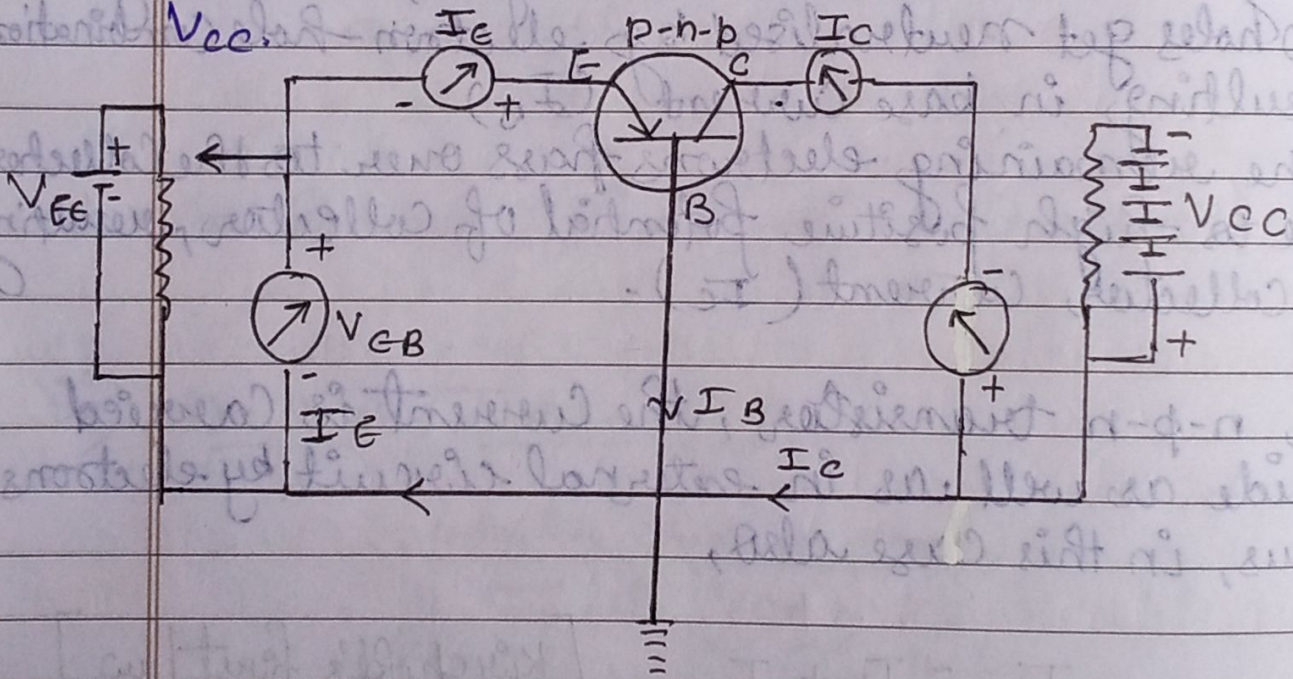

* The Common base Characteristics of a transistor are of two types:

a) Input Characteristics | Emitter characteristics

A graphical relation b/w the emitter voltage and emitter current at constant collector voltage. is called emitter or input characteristics.

The Graph is plotted b/w emitter current & corresponding emitter voltage.

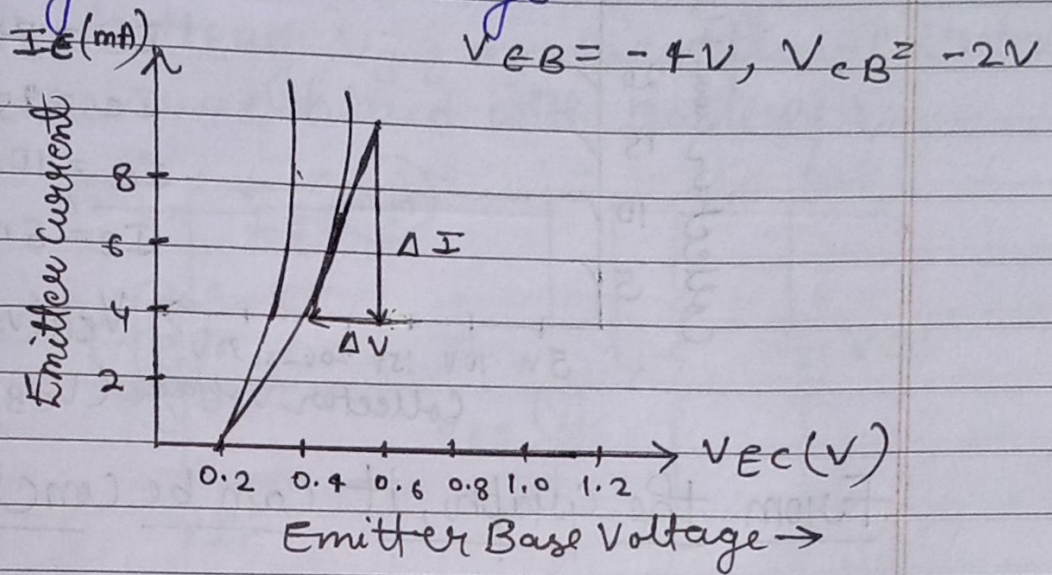

From the graph it can be concluded that:

i) For a given collector voltage, the emitter current increases rapidly with increase in value of emitter base voltage.

It means that input resistance is very small.

ii) For a higher negative collector voltage, the emitter current rises more rapidly with the collector voltage.

b) Output characteristics / collector characteristics

A graphical relation b/w the collector voltage & collector current at constant emitter current, is called collector or output characteristics.

The graph is plotted b/w collector current and corresponding collector voltage.

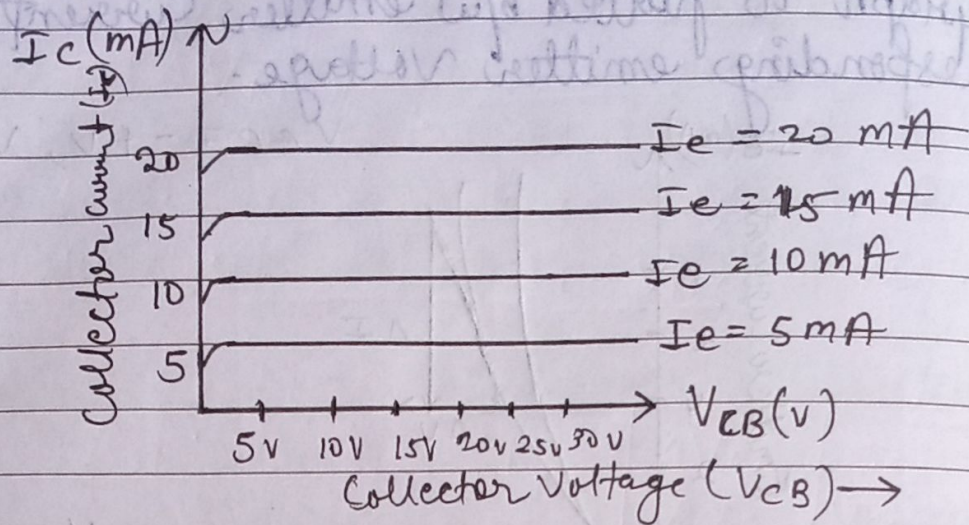

From the graph, it can be concluded that:

- i For a given value of emitter current, the collector current is not zero when collector voltage is zero.
- ii For a given emitter current, there is a rapid increase in the collector current for an increase in low negative collector voltage. This shows the region of low collector resistance.
- iii For a given emitter current, the collector current becomes saturated for a certain collector voltage shown by horizontal line.

Beyond this there is no change in collector current for a further increase in negative collector voltage. This indicates a region of high collector resistance.

* Common Emitter Transistor Characteristics :-

Here, base-emitter circuit is forward biased with battery V_{BE} and emitter-collector circuit is reversed biased with battery V_{CC} .

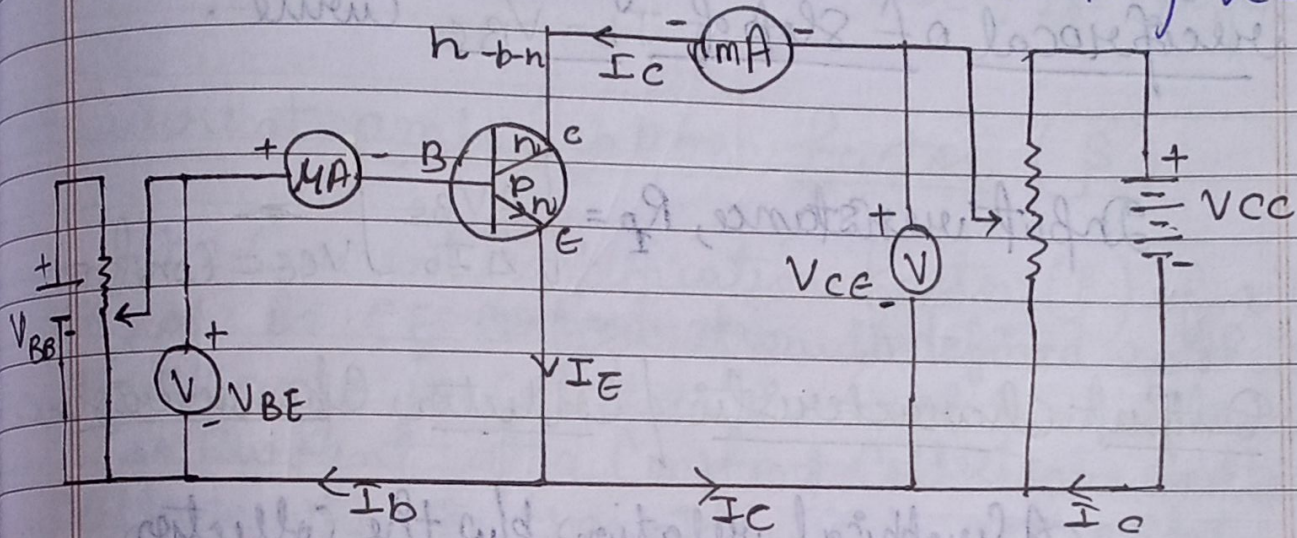

There are 2 types of Common emitter characteristics.

① Input Characteristics / Emitter Characteristics:

A graphical relation b/w the emitter voltage and the emitter current by keeping collector voltage constant is called input characteristics of the transistor.

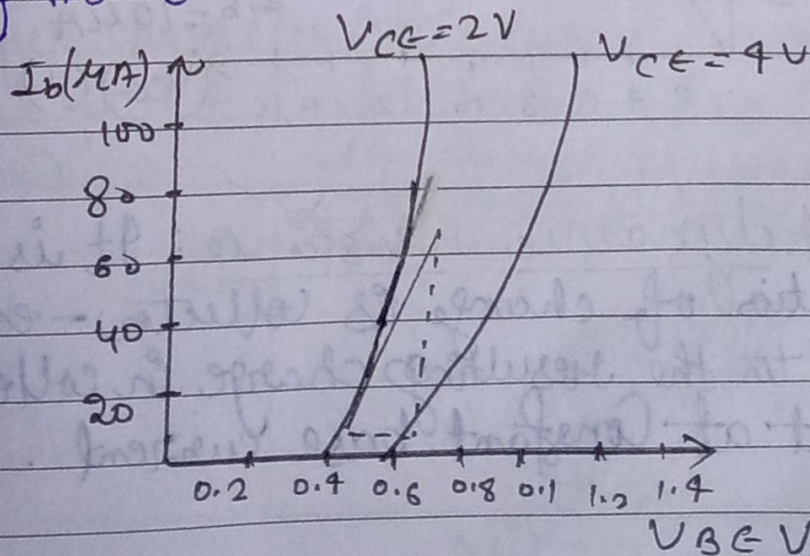

Input dynamic resistance: It is defined as the ratio of change in base-emitter voltage (ΔV_{BE}) to the resulting change in the base current (ΔI_b) at constant collector-emitter voltage (V_{CE}). It is reciprocal of slope of $I_b - V_{BE}$ curve.

$$\text{Input resistance, } R_p = \left[\frac{\Delta V_{BE}}{\Delta I_b} \right]_{V_{CE} = \text{Constant}}$$

b) Output characteristic / Collector Characteristics

A Graphical relation b/w the collector voltage and collector current by keeping base current constant is called output characteristics of the transistors.

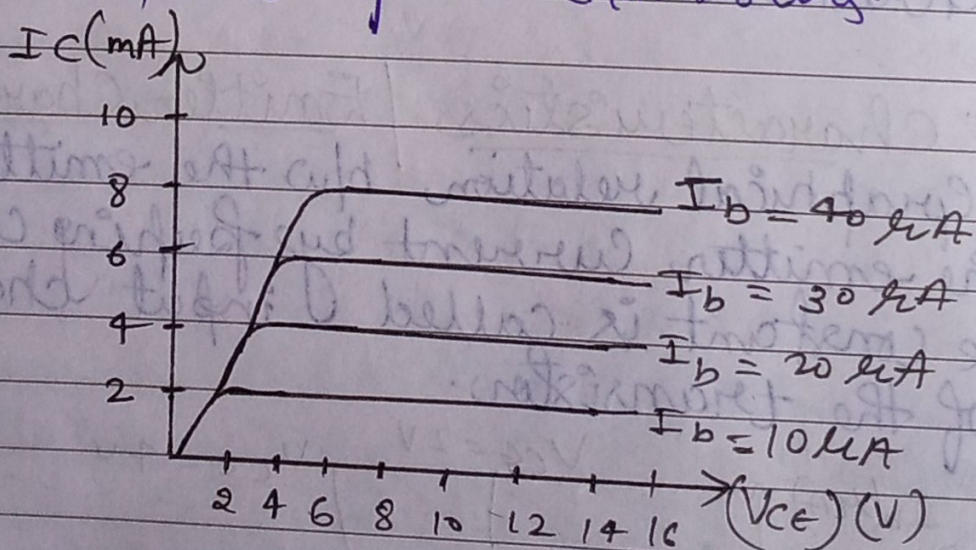

Output dynamic resistance: It is defined as the ratio of change in collector-emitter voltage to the resulting change in collector current at constant base current.

It is reciprocal of Slope of $I_c - V_{ce}$ Curve.

Output resistance, $R_o = \left[\frac{\Delta V_{ce}}{\Delta I_c} \right]_{I_b = \text{Constant}}$

→ Current amplification factor (β):

The Current amplification factor (β) of a Transistor in CE Configuration is defined as the ratio of change in collector current to the change in base current at a constant collector-emitter voltage when the transistor is in active state.

$\beta_{ac} = \left[\frac{\Delta I_c}{\Delta I_b} \right]_{V_{ce} = \text{Constant}}$

Its value is very large ($\beta_{ac} \gg 1$).

* Transfer Characteristics Curve

Transfer characteristics curve for a base-biased transistor in CE Configuration, as shown below:

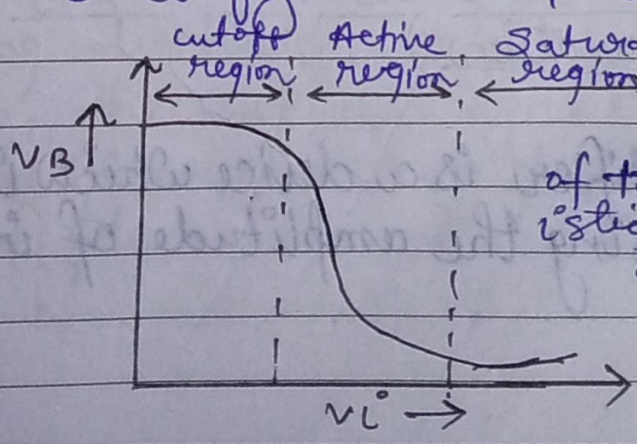

The active region of transfer characteristics curve operates as an amplifier

Region of operation of

Region	Collector junction	Emitter junction
cut-off	Reverse biased	Reverse biased
Active	Reverse biased	Forward biased
Saturation	Reverse biased	Forward biased

As V_i increases slightly above 0.6V, a current I_c flows in the output circuit & the transistor arrives in active state.

$$\therefore V_o = V_{cc} - I_c R_c$$

with the growth of I_c , V_c decreases linearly.

Also, voltage gain in active state is given by $(\because \Delta V_o > \Delta V_i)$

$$\Delta V = -\frac{\Delta V_o}{\Delta V_i}$$

There is voltage gain and hence amplification of voltage take place. Thus, transistor used as an amplifier.

Transistor as an amplifier : (CE Configuration)

→ An amplifier is a device which is used for increasing the amplitude of input signal.

The circuit diagram for p-n-p transistor as an amplifier is shown in the fig. given below:

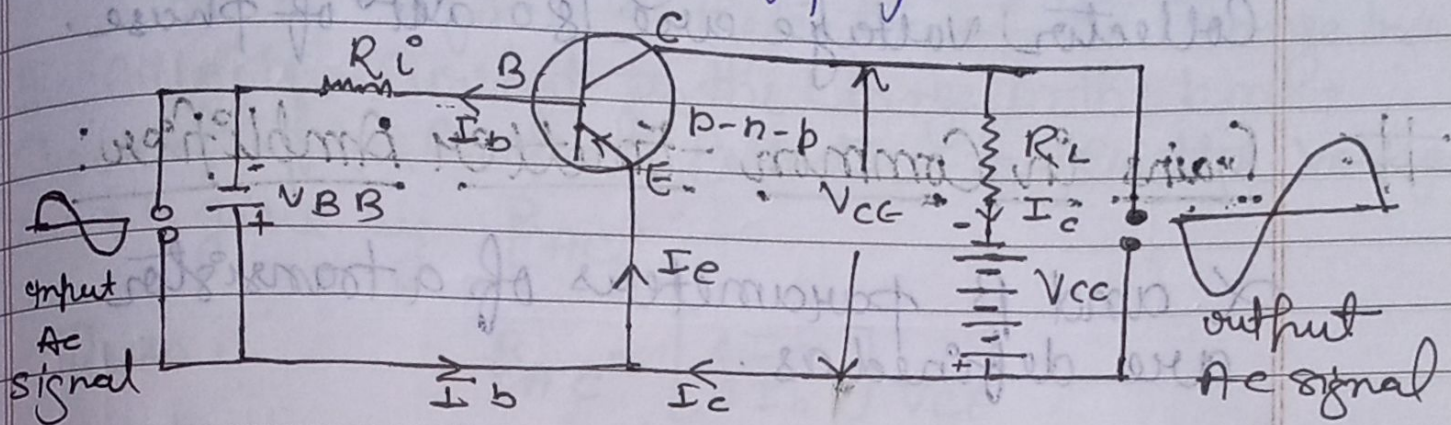

When no AC Voltage is applied to the input circuit we have.

$$I_e = I_b + I_c$$

Due to Collector Current I_c , the voltage drop across load resistance (R_L) is $I_c R_L$

Therefore, the collector-emitter voltage V_{CE} is given by.

$$V_{CE} = V_{CC} - I_c R_L$$

During +ve half cycle of input a.c. signal voltage, the output signal voltage at the collector varies through -ve half cycle i.e, 180° out of phase.

Similarly, during -ve half cycle of input a.c. signal voltage, the output signal voltage at the collector varies through +ve half cycle. i.e, 180° out of phase.

Thus, is common emitter transistor amplifier circuit, the input signal voltage & the output collector voltage are 180° out of phase.

Gains in Common-Emitter Amplifier:

α and β parameters of a transistor are defined as.

$$\alpha = \frac{I_c}{I_e}, \alpha \text{ is about } 0.95 \text{ to } 0.99.$$

$$\beta = \frac{I_c}{I_b}, \beta \text{ is about } 15 \text{ to } 100.$$

The various gains in a common-emitter amplifier are as follows:

i) DC Current Gain

It is defined as the ratio of the collector current to the base current and is denoted by β_{DC} .

Thus,

$$\beta_{DC} = \frac{I_c}{I_b} = \frac{I_c}{I_e - I_c} = \frac{I_c/I_e}{1 - I_c/I_e}$$

$$\left[\beta = \frac{\alpha}{1 - \alpha} \right]$$

$$[\because I_e = I_b + I_c]$$

$$[\because \alpha = I_c/I_e]$$

ii) AC Current Gain

It is defined as the ratio of the change in the collector-current to the change in the base-current at a constant collector-to-emitter voltage, and is given by β_{AC} .

Thus,
$$\beta_{AC} = \left[\frac{\Delta I_C}{\Delta I_B} \right]_{V_{CE}}$$

iii) AC Voltage Gain

It is defined as the ratio of the change in the output voltage to the change in the input voltage & is denoted by A_v .

Suppose on applying an AC input voltage signal, the input base-current changes by ΔI_B & correspondingly the output collector-current changes by ΔI_C . If R_{input} & R_{output} be the resistances of the input & the output circuits respectively then

$$\left[A_v = \frac{\Delta I_C \times R_{out}}{\Delta I_B \times R_{inp}} = \frac{\Delta I_C}{\Delta I_B} \times \frac{R_{out}}{R_{inp}} \right]$$

$$\therefore \beta_{AC} = \frac{\Delta I_C}{\Delta I_B}$$

iv) AC Power Gain

It is defined as the ratio of the change in the output power to the change in the input power.

Since, Power = Current \times Voltage,
we have,

$$\text{AC power Gain} = \text{AC current Gain} \times \text{AC Voltage Gain}$$

$$[= \beta_{AC} \times A_v]$$

→ Relation $\frac{b/w}{\alpha}$ and β .

$$\left[\beta = \frac{\alpha}{1-\alpha} \right] \text{ and } \left[\alpha = \frac{\beta}{1+\beta} \right]$$

* Analog Signals:

A signal in which current or voltage changes continuously with the time is called analog signals.

* Digital Signals

A signal in which current or voltage can take only two discrete values (represented by 0 & 1) is called a digital signal.

Logic Gate

These are building blocks of electronic circuits. In logic gates, there exist a logical relationship b/w output & input(s).

* Truth Table

It is a table that shows all possible input combinations & the corresponding output combinations for a logic gates.

* Boolean Expression

The expression shows the combination of two Boolean variables that results into a new Boolean variable is known as Boolean expression.

* Basic Gates:

There are three basic gates:

$$[A \cdot B = Y]$$

OR Gate

Boolean expression of OR gate is given as.

$$[Y = A + B.]$$

- a) It has 2 or more inputs & one output.
- b) In this gate, if any one of the input or all the inputs are 1, then output is 1.

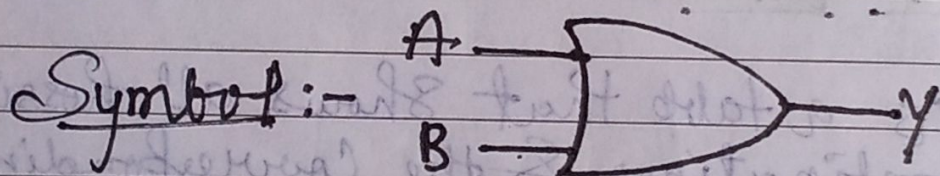

Truth Table

A	B	Y
0	0	0
0	1	1
1	0	1
1	1	1

ii

AND Gate

Boolean expression of AND gate is given as

$$[Y = A \cdot B]$$

- a) It has 2 or more inputs & one output.
- b) It has output 1 only when all inputs are 1.

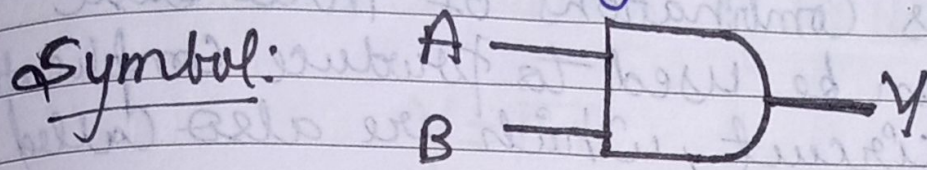

Truth Table:

A	B	Y
0	0	0
0	1	0
1	0	0
1	1	1

iii) NOT Gate

Boolean expression of NOT gate is $Y = \bar{A}$

$$[Y = \bar{A}]$$

- a) It has one input & one output.
- b) It gives an inverted version of its input i.e. if input is 1, then output is 0 & vice-versa.

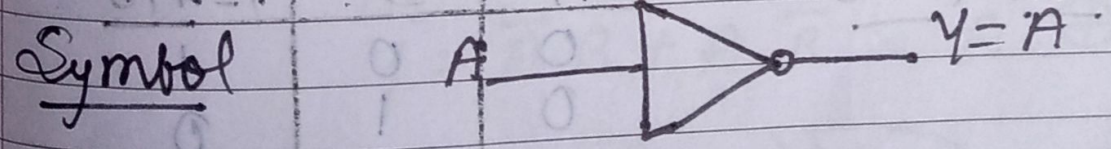

Truth Table:

A	Y
0	1
1	0

* Combination of Gates

Various combinations of three basic gates can be used to produce complicated digital circuit, which are also called gates.

Different combinations of basic gates are given below:

→ NOR Gate

Boolean expression of NOR gate is given as.

$$[Y = \overline{A+B}]$$

- Here NOT Operation is applied after OR Gate.
- If all its inputs are 0, then its output will be 1.

Symbol

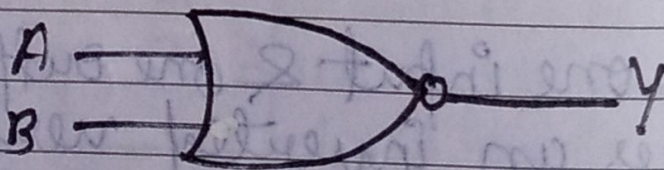

Truth Table

A	B	$Y = \overline{A+B}$
0	0	1
0	1	0
1	0	0
1	1	0

→ universal Gate

Date: _____ Page: _____

→ NAND Gate

Boolean expression of NAND Gate is given as

$$Y = \overline{A \cdot B}$$

- Here AND gate followed by a NOT Gate
- If all the input are 1. Then output will be 0.

Symbol:

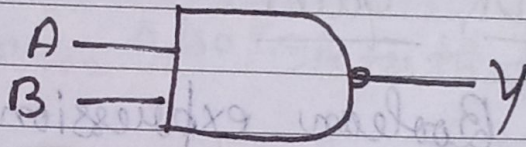

Truth table

A	B	$Y = \overline{A \cdot B}$
0	0	1
0	1	1
1	0	1
1	1	0

→ NAND and NOR gates are called universal gates

* XOR Gate

Boolean expression of XOR Gate is given as

$$Y = \overline{A} \cdot B + A \cdot \overline{B} = A \oplus B$$

Symbol:

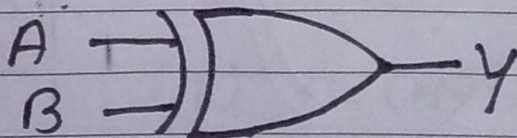

Truth Table

A	B	$Y = A \oplus B$
0	0	0
0	1	1
1	0	1
1	1	0

* XNOR Gate

Boolean expression of XNOR gate is given as

$$Y = \overline{A \cdot B} = \overline{A} \cdot \overline{B} + A \cdot B$$

Here, XOR gate is followed by a NOT Gate.

Shape:

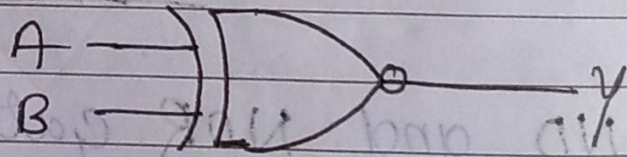

Truth Table

A	B	$Y = \overline{A \cdot B}$
0	0	1
0	1	0
1	0	0
1	1	1

* Some Useful Laws of Boolean Algebra:

i) de-Morgan's Theorem

It states that the complement of the whole sum is equal to the product of individual complements & vice-versa

$$a) \overline{A+B} = \bar{A} \cdot \bar{B} \quad b) \overline{A \cdot B} = \bar{A} + \bar{B}$$

de-Morgan's theorem also states that

$$a) \overline{\bar{A} + \bar{B}} = \overline{\bar{A}} \cdot \overline{\bar{B}} = A \cdot B \quad b) \overline{\bar{A} \cdot \bar{B}} = \overline{\bar{A}} + \overline{\bar{B}} = A + B$$

ii) Commutative laws

$$a) A + B = B + A \quad b) A \cdot B = B \cdot A$$

iii) Associative laws

$$a) A + (B + C) = (A + B) + C \quad b) A \cdot (B \cdot C) = (A \cdot B) \cdot C$$

iv) Distributive laws

$$a) A \cdot (B + C) = A \cdot B + A \cdot C \quad b) (A + B) \cdot (A + C) = A + B \cdot C$$

v) Absorption laws

$$a) A + A \cdot B = A \quad b) A \cdot (A + \bar{A}) = A$$

$$c) \bar{A} \cdot (A + B) = \bar{A} \cdot B$$

Logic gates

Analog Signal - A continuous time varying current or voltage signal is called analog signal.

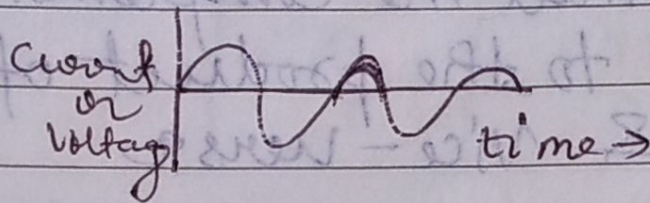

Digital Signal - The signal which have only (two) value level value 0 & 1 it means this signal have 2 levels of current or voltage.

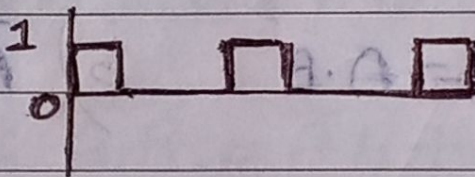

Logic gates

A gate is a digital circuit which follows certain logical relationship b/w input & output.